

# FD322 ASSEMBLY DIAGRAM

See Detail B

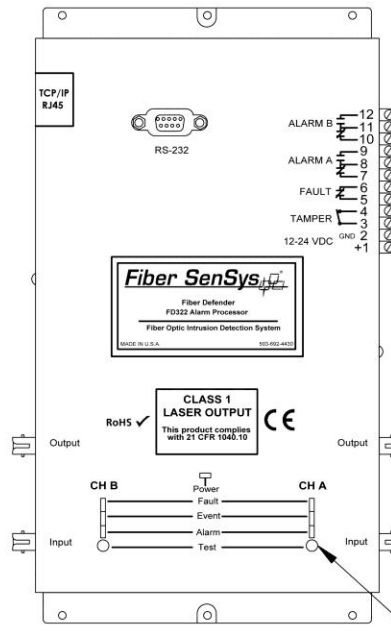

See Detail A

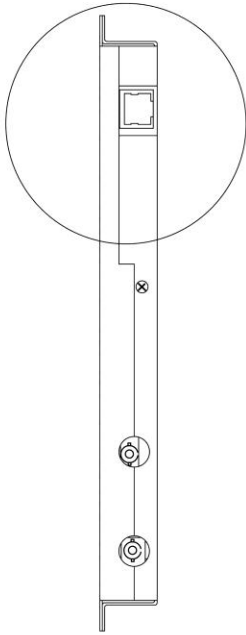
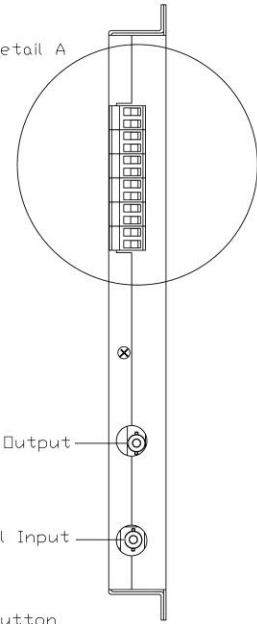

IP/XML Option

## DETAIL B

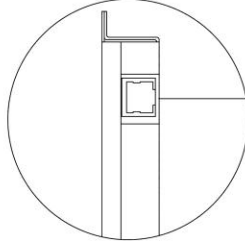

RJ-45 Connector

## DETAIL A

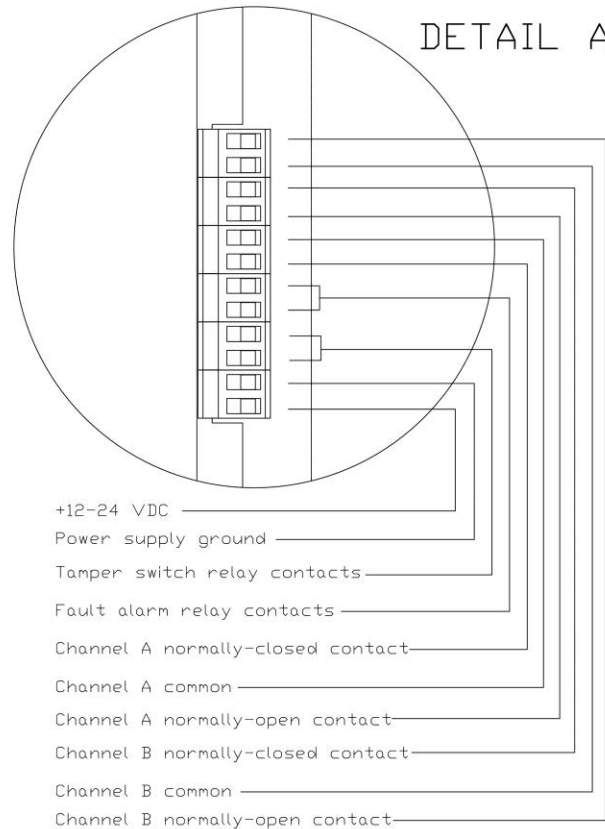

# FD322 ENCLOSURE DIAGRAM

Front View

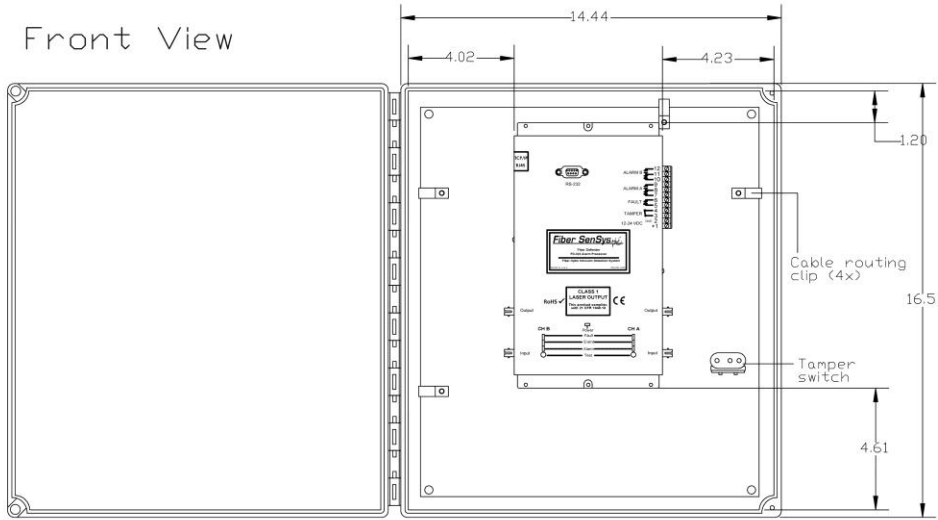

Bottom View

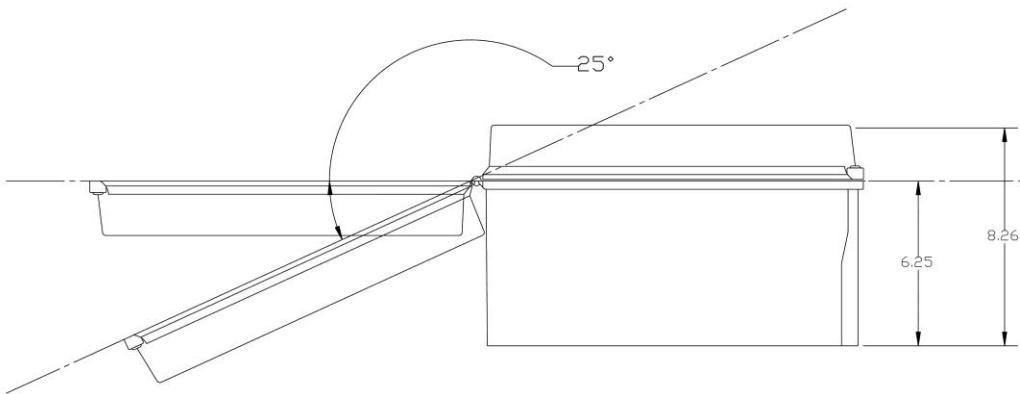

# FD322 APPLICATION BLOCK DIAGRAM

